

2MP WDR Vandal-resistant Network IR Fixed Dome Camera

IPC322SR3-DVPF28 (40) -C



Key Features

Optics

- Day/night functionality
- Smart IR, up to 30 m (98 ft) IR distance
- Car-grade LEDs, brighter and uniform light compensation
- Up to 120 dB WDR (Wide Dynamic Range)
- 2D/3D DNR (Digital Noise Reduction)

Compression

- Ultra 265, H.265, H.264, MJPEG
- Embedded smart algorithm
- Triple streams
- ROI (Region of Interest)
- Customized OSD

Network

- ONVIF Conformance

Structure

- Wide temperature range: -35°C to 60°C (-31°F to 140°F)

- Wide input voltage range of $\pm 25\%$
- IK10 vandal resistant
- 3-Axis
- IP67

Specifications

	IPC322SR3-DVPF28-C	IPC322SR3-DVPF40-C
Camera		
Sensor	1/2.7", progressive scan ,2.0 megapixel, CMOS	
Lens	2.8 mm@F2.0	4.0 mm@F2.0
Angle of View (H)	112.7°	86.5°
Shutter	Auto/Manual, 1/6~1/100000 s	
Minimum Illumination	Colour: 0.01 Lux (F2.0, AGC ON) 0 Lux with IR	
Day/Night	IR-cut filter with auto switch (ICR)	
Digital noise reduction	2D/3D DNR	
S/N	>52 dB	
IR Range	Up to 30m (98 ft) IR range	
Defog	Digital Defog	
WDR	120dB	
Video		
Video Compression	Ultra 265,H.265, H.264, MJPEG	
H.264 code profile	Baseline profile, Main Profile, High Profile	
Frame Rate	Main Stream:2MP (1920×1080): Max. 30 fps; Sub Stream:2MP (1920×1080): Max. 30 fps; Third Stream:D1 (720×576): Max. 30 fps	
9:16 Corridor Mode	Supported	
HLC	Supported	
BLC	Supported	
OSD	Up to 8 OSDs	
Privacy Mask	Up to 8 areas	
ROI	Up to 8 areas	
Motion Detection	Up to 4 areas	
Smart		
Behavior Detection	Intrusion, cross line, motion detection	
Exception Detection	Audio detection	
Intelligent Identification	Face detection, Defocus, Scene Change	
Statistical Analysis	People counting	
General Function	Watermark, IP Address Filtering, Tampering Alarm, Alarm input, Alarm output, Access Policy, ARP Protection, RTSP Authentication, User Authentication	
Audio		
Audio Compression	G.711	
Two-way audio	Supported	

Suppression	Supported
Sampling Rate	8 KHZ
Storage	
Edge Storage	Micro SD, up to 128 GB
Network Storage	ANR
Network	
Protocols	IPv4, IGMP, ICMP, ARP, TCP, UDP, DHCP, PPPoE, RTP, RTSP, RTCP, DNS, DDNS, NTP, FTP, UPnP, HTTP, HTTPS, SMTP, 802.1x, SNMP
Compatible Integration	ONVIF(Profile S, Profile G), API
Interface	
Audio I/O	Input: impedance 35 k Ω ; amplitude 2 V [p-p]
	Output: impedance 600 Ω ; amplitude 2 V [p-p]
Alarm I/O	1/ 1
Network	1 RJ45 10M/100M Base-TX Ethernet
General	
Power	12 V DC \pm 25%, PoE (IEEE802.3 af)
	Power consumption: Max 5.5W
Dimensions (\varnothing x H)	\varnothing 108.5 x 81 mm (\varnothing 4.28" x 3.2")
Weight	0.45 kg (0.99 lb)
Working Environment	-35°C ~ +60°C (-31°F ~ 140°F), Humidity :10%~90% RH(non-condensing)
Ingress Protection	IP67
Vandal Resistant	IK10

Dimensions

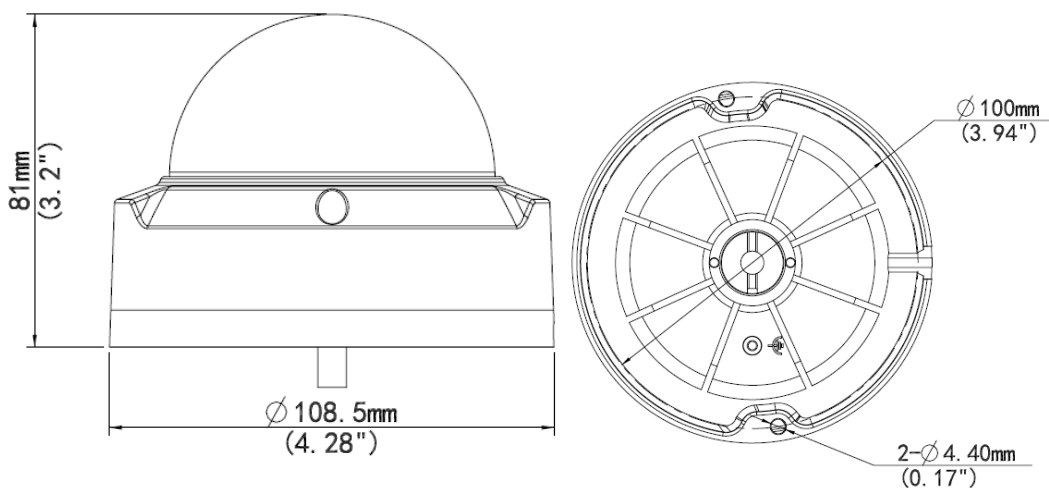

Accessories

Installation mode	Accessories	Description
Ceiling mount	Mounting pedestal is included in the Product package	TR-JB03-D-IN junction box and TR-A01-IN waterproof joint for the junction is optional

Zhejiang Uniview Technologies Co., Ltd.

South Tower, Building 10, Wanlun Science Park, 88 Jiangling Road, Hangzhou, P.R.China 310051

Email: overseasbusiness@uniview.com; globalsupport@uniview.com

<http://www.uniview.com>

©2017 Zhejiang Uniview Technologies Co., Ltd. All rights reserved.

*Product specifications and availability are subject to change without notice.