

2MP Fixed Dome Network Camera

IPC322LR3-VSPF28(40)-C



Key Features

Optics

- Day/night functionality
- SmartIR, up to 30 m (98 ft) IR distance
- Car-grade LEDs, brighter and uniform light compensation
- 2D/3D DNR (Digital Noise Reduction)

Compression

- Ultra 265, H.265, H.264, MJPEG
- Triple streams
- ROI (Region of Interest)

Network

- ONVIF Conformance

Structure

- Wide temperature range: -30°C to 60°C (-22°F to 140°F)
- Wide input voltage range of $\pm 25\%$
- 2-Axis
- IK10 vandal resistant
- IP66

Specifications

	IPC322LR3-VSPF28-C	IPC322LR3-VSPF40-C
Camera		
Sensor	1/2.7", progressive scan , 2 megapixel, CMOS	
Lens	2.8 mm@ F2.2	4.0 mm@ F2.2
Angle of View (H)	105.2°	76.6°
Shutter	Auto/Manual, 1/6~1/100000 s	
Minimum Illumination	Colour: 0.2 Lux (F2.2, AGC ON) 0 Lux with IR	
Day/Night	IR-cut filter with auto switch (ICR)	
Digital noise reduction	2D/3D DNR	
S/N	>52dB	
IR Range	Up to 30m (98 ft) IR range	
Defog	Digital Defog	
WDR	DWDR	
Video		
Video Compression	Ultra 265,H.265, H.264,MJPEG	
H.264 code profile	Baseline profile, Main Profile, High Profile	
Frame Rate	Main Stream: 2MP (1920×1080): Max. 25 fps; Sub Stream:720P (1280×720): Max. 25 fps; Third Stream:D1(720×576) : Max. 25fps	
HLC	Supported	
BLC	Supported	
OSD	Up to 8 OSDs	
Privacy Mask	Up to 4 areas	
ROI	Supported	
Motion Detection	Up to 4 areas	
General Function	Watermark, IP Address Filtering, Tampering Alarm, Access Policy, ARP Protection, RTSP Authentication, User Authentication	
Network		
Protocols	IPv4, IGMP, ICMP, ARP, TCP, UDP, DHCP, RTP, RTSP, RTCP, DNS, DDNS, NTP, FTP, UPnP, HTTP, HTTPS, SMTP	
Compatible Integration	ONVIF(Profile S), API	
Interface		
Network	1 RJ45 10M/100M Base-TX Ethernet	
General		
Power	12 V DC±25%, PoE (IEEE802.3 af)	
	Power consumption: Max 5.0W	
Dimensions (Ø x H)	Φ108.5 x 81 mm (Ø4.28" x 3.2")	
Weight	0.3 kg (0.66 lb)	
Working Environment	-30°C ~ +60°C (-22°F ~ 140°F), Humidity:10%~95% RH(non-condensing)	
Ingress Protection	IP66	
Vandal Resistant	IK10	

Dimensions

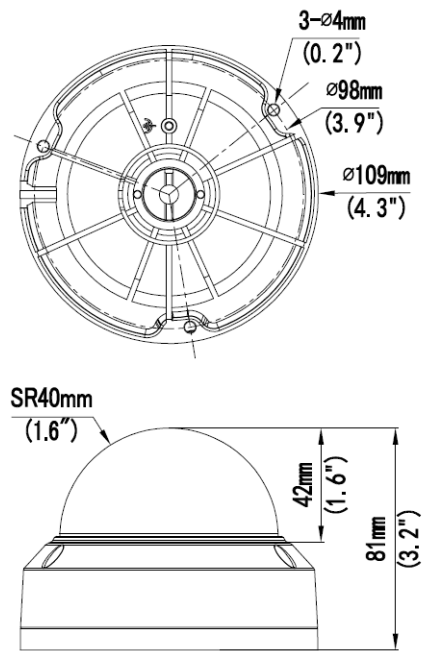

Zhejiang Uniview Technologies Co., Ltd.

South Tower, Building 10, Wanlun Science Park, 88 Jiangling Road, Hangzhou, P.R.China 310051

Email: overseasbusiness@uniview.com; globalsupport@uniview.com

<http://www.uniview.com>

©2017 Zhejiang Uniview Technologies Co., Ltd. All rights reserved.

*Product specifications and availability are subject to change without notice.